

Indoor

ATG's Helix High Bay is an evolution of commercial high bay lighting. The Helix High Bay is ideally deployed for use in distribution centers, manufacturing facilities, and large retail facilities with ceilings of 20 to 40 feet.



Luminaire	Helix High Bay	Type
Project		
Product		
Notes		

1. IP65 Rated
2. Superior glare prevention and light quality
3. Best mounted at a range of 20 to 40 feet



Input Voltage (VAC)	100-240/277 347-480
CRI	70+
	3500*
CCT (K)	4000
	5000
PF	0.9
THD	<20%
L70 (Hours)	95,000
Color	Black
Housing	Cast & Extrusion Aluminum
Optic Types	Clear
Temperature Range	-40°C to 49°C
Warranty	10 Years

*contact sales for lead time:
CCT 3500K, 4000K
347-480 VAC

Mounting

The luminaire is can be mounted by cable, bracket, or pendant*. Maximum recommended installation height for the Helix High Bay is 40 ft. The slim profile allows for exceptionally versatile placement compared to traditional high bays.

*pendant kit available, pole not included

Electrical

Luminous efficacy is an excellent 140 Lm/W. Luminaire lifespan is rated at 95,000 hours. Standard input voltage is 100-240/277 and 347-480V drivers are available on all units. Fixture is IP65 rated.

Construction

The Helix High Bay housing is formed from cast and extruded aluminum. Our streamlined manufacturing process delivers a more versatile product with a superior value proposition. Customers may order an optional aluminum shroud to further control light output.

Optics

The Helix High Bay's clear, polycarbonate lens and rolled aluminum reflector enhance beam output for commercial uses. CCT is rated at 5000K for optimal performance in industrial environments. The CRI of 70+ provides color fidelity for visually sensitive tasks.

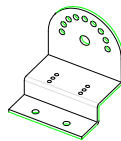
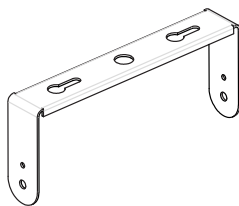

bracket

*pendant kit available, pole not included

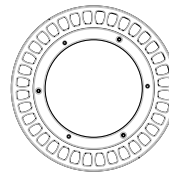

Bottom

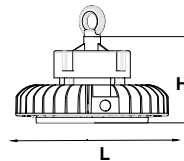

Profile

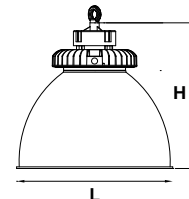

With Shroud

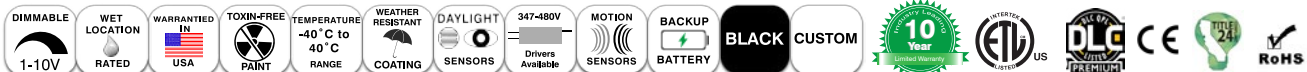

Part No.	Watts (W)	Efficacy (Lm/W)	Lumens (Lm)	Dimensions (L*W*H) Inches
HBUF-100W-50-C	99	141	14,000	10.24*5.75 with shroud 16*16.62 18*17.56
HBUF-150W-50-C	153	142	21,730	10.24*5.75 with shroud 16*16.62 18*17.56
HBUF-200W-50-C	196	140	27,500	11.42*6.63 with shroud 16*17.50 18*18.44
HBUF-250W-50-C	241	140	33,740	11.42*6.63 with shroud 16*17.50 18*18.44

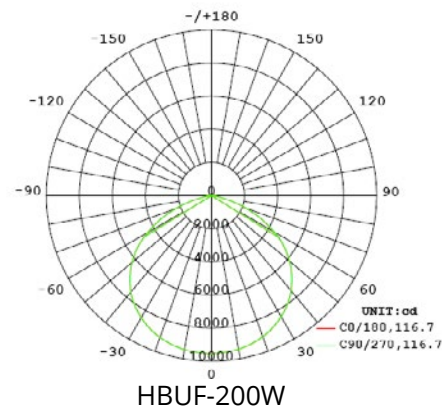
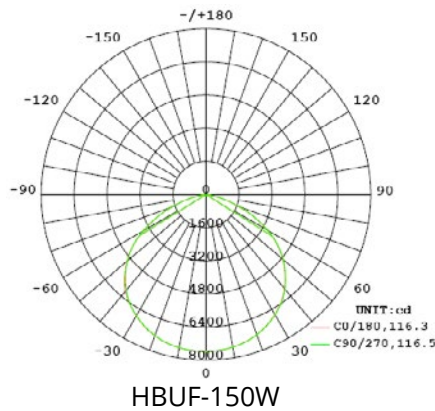

File Name	Wattage	System Wattage	Lumens	Efficacy
5000K				
HBUF-100W	100	99.37	14000	141
HBUF-150W	150	153.40	21746	142
HBUF-200W	200	196.30	27500	140
HBUF-250W	250	240.80	33735	140
4000K				
HBUF-100W	100	100.90	13512	133.92
HBUF-150W	150	151.60	20659	136.27
HBUF-200W	200	202.10	26125	129.27
HBUF-250W	250			

5000K -Acrylic Reflector-16 inch				Acrylic Reflector-22 inch					
File Name	Wattage	System Wattage	Lumens	Efficacy	File Name	Wattage	System Wattage	Lumens	Efficacy
HBUF-100W	100				HBUF-100W	100			
HBUF-150W	150	154.00	19323	125.47	HBUF-150W	150	154.50	18920	122.46
HBUF-200W	200	201.40	24677	122.53	HBUF-200W	200	201.10	24143	120.05
HBUF-250W	250				HBUF-250W	250			
4000K									
HBUF-100W	100		11920		HBUF-100W	100		11634	
HBUF-150W	150		18357		HBUF-150W	150		17974	
HBUF-200W	200		23443		HBUF-200W	200		22936	
HBUF-250W	250				HBUF-250W	250			

5000K -Acrylic Reflector-17 inch				Acrylic Reflector-18 inch					
File Name	Wattage	System Wattage	Lumens	Efficacy	File Name	Wattage	System Wattage	Lumens	Efficacy
HBUF-100W	100				HBUF-100W	100			
HBUF-150W	150	154.00	19323	125.47	HBUF-150W	150	155.50	16893	108.64
HBUF-200W	200	201.40	24677	122.53	HBUF-200W	200	202.10	21624	107.00
HBUF-250W	250				HBUF-250W	250			
4000K									
HBUF-100W	100		11920		HBUF-100W	100		10320	
HBUF-150W	150		18357		HBUF-150W	150		16048	
HBUF-200W	200		23443		HBUF-200W	200		20543	
HBUF-250W	250				HBUF-250W	250		25412	

Sample Order: HBUF-150W-50-C-G2

Series	Wattage	CCT	Voltage	Dimming	Lens	Generation
HBUF= High Bay Helix	-100W=100W -150W=150W -200W=200W -250W=250W	-50=5000K	Blank=100-277V -V=347-480V	Blank=1-10V Dimming -ND=Non-Dimming	-C=Clear Lens -F=Frosted Lens	-G2=2nd Generation

Mounting Bracket

Piece A attaches to fixture
dimensions in mm

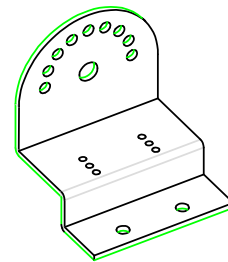
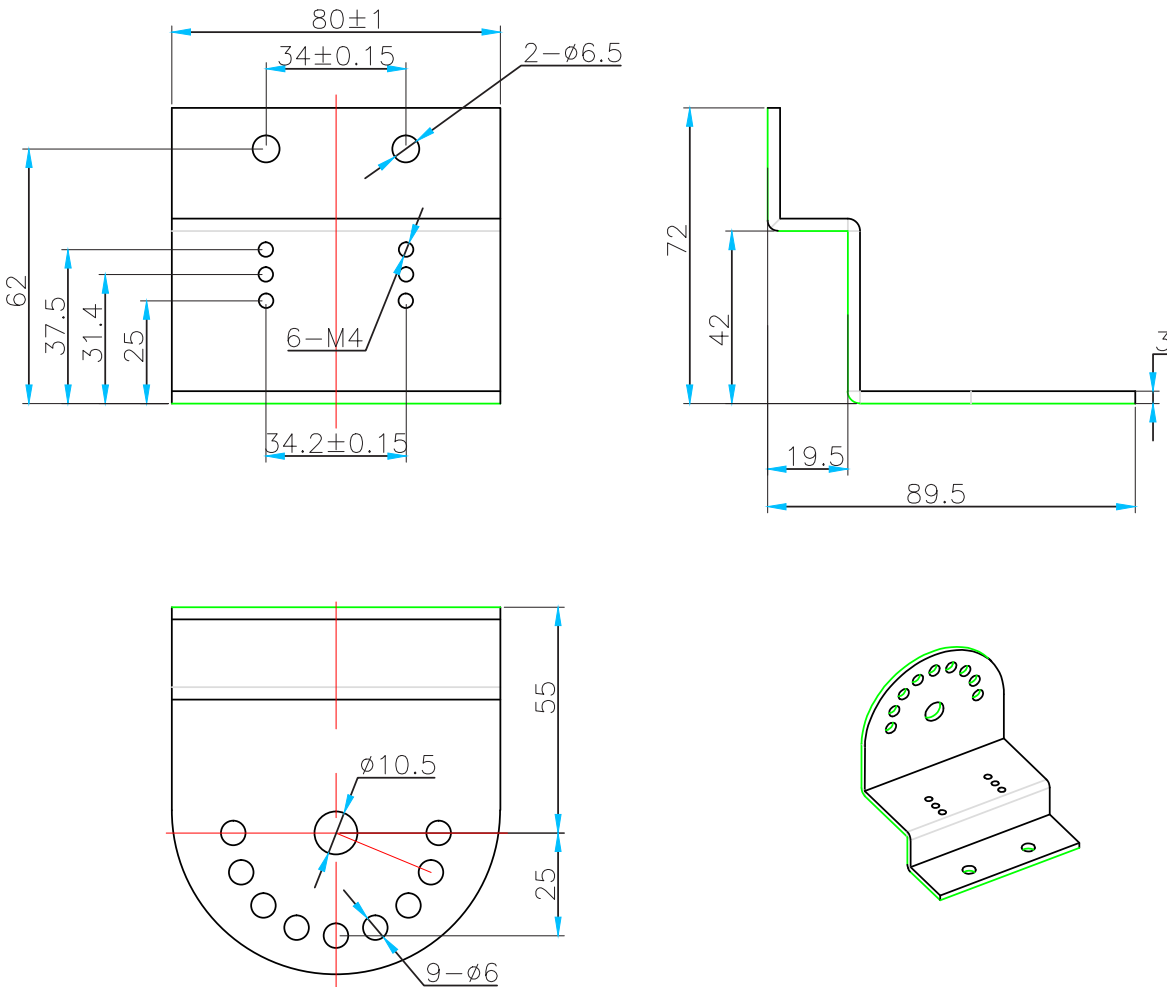

Mounting Bracket

Piece B attaches to Piece A
dimensions in mm

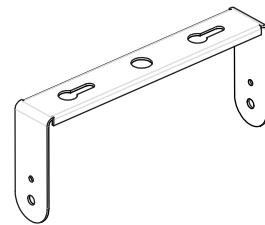
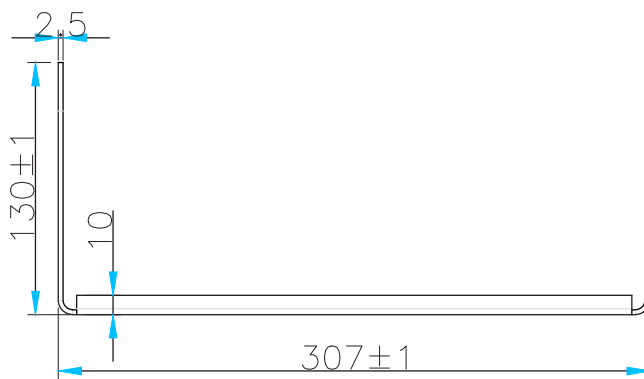
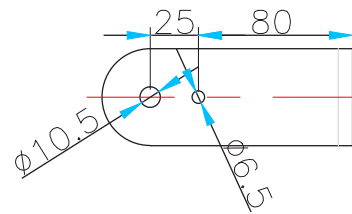
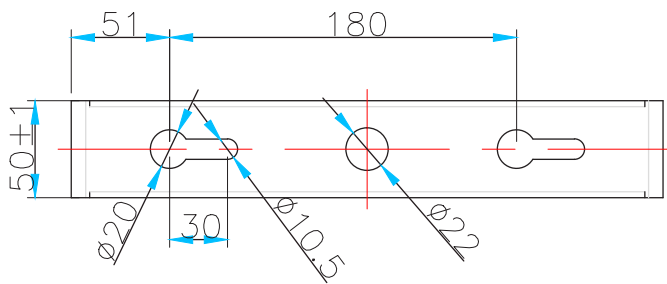

LOD-500SFC

Power Supply	120/277VAC, 50,60 Hz
Maximum Blend	800W
Infrared Speed	Omni-directional quad element pyroelectric
Detectable Speed	0.15-3m/sec(0.5-10 ft/sec)
Mounting Height	Subject to the lens type applied
Detection Range	Subject to the lens type applied and height
Zero Crossing	Automatic frequency detection
Low Dim Control	0-10V
Dim Output Current	Max. 400uA @120VAC Max 2.5mA @277VAC
Low Dim Level	0/5/10/20/25/33/50% selectable
Ambient Light Level	L:20-50 lux, M:80-130 lux, H:500-600 lux
Delay Time Setting	1'/3'/5'/10'/15'/20'30' selectable
Time-off Delay	10 min, TO modes only
Op. Humidity	Max. 95%RH
Op. Temperature	-40C 55C (-40F -131F)
Dimensions	2.36"x H1.45"

Emergency Driver

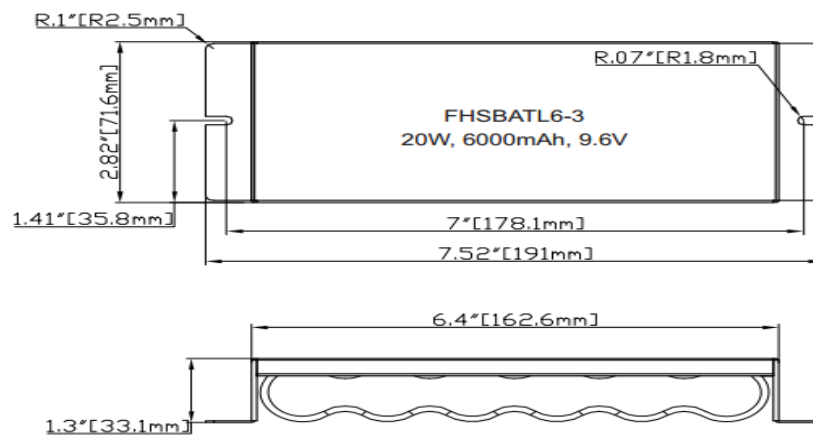

Emergency Battery

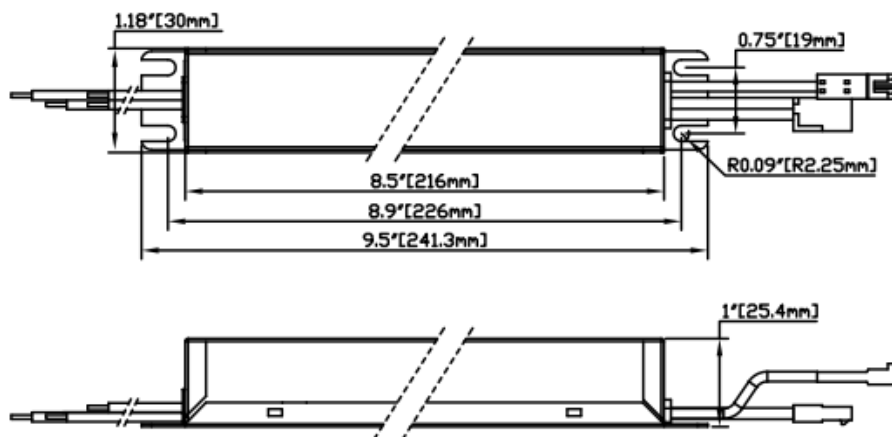

ATG Electronics®
Industry Leading 10 Year Limited Warranty
For North American LED Lighting Fixtures

ATG Electronics warrants to the original purchaser of ATG Electronics Domestic LED products listed above that were manufactured for which the ATG Electronics Spec Sheet located on our website contains the words "10 year limited warranty" that, subject to the below terms and conditions of this warranty, when such LED products are properly installed they will comply with ATG Electronics published product specifications for such products and will be free from material defects in material and workmanship for a period of ten (10) years from the date of sale by ATG Electronics, or, if lesser, 50,000 hours of operation (at an average of 13.6 hours per day operation). The LED arrays in the Product(s) will be considered defective in material or workmanship only if a total of 15% or more of the individual light emitting diodes in the Product(s) fail to illuminate.

The above express limited warranty is extended by ATG Electronics® only to the original or first end-user purchaser and only for the original installed location. This warranty only applies to products purchased after June 1, 2017. This warranty is non-transferrable, whether by assignment or operation of law. The original purchaser must provide warranty claims to ATG Electronics within the warranty period promptly upon discovery and in accordance with ATG Electronics Return and Repair Procedures as outlined within this document.

Should any defects be found by ATG Electronics upon its inspection of the properly returned product, ATG Electronics sole responsibility and liability under this warranty will be, at its option, to either repair or replace the defective part or parts or else make available a new replacement unit that will provide equal or better performance. All decisions regarding the existence or non-existence of defects or otherwise affecting the warranty shall be made by ATG ELECTRONICS and shall be final and binding on all parties. Where a defective LED product is replaced under this warranty, the balance of the original warranty period shall remain effective.

Conditions and Exclusions

This warranty is conditioned upon proper installation, use and maintenance. This warranty will automatically become null and void and shall not be applicable to any LED fixture which (i) has not been timely paid for, (ii) is not installed and operated in accordance with the current edition of The National Electric Code (NEC), the Standards for Safety of Underwriters' Laboratory, Inc. (UL) or with ATG Electronics instructions and guidelines, (iii) has been moved from its original installation, (iv) has been installed within an area that has exposure to sulfur or any area with high acidic compounds in use, (v) has been operated in an ambient temperature or humidity that is higher than 35 degrees Celsius, (vi) has been subjected to a lightning strike, power surge or overvoltage condition, (vii) has its LED Board subjected to static electricity due to failure to discharge same prior to connecting or disconnecting the lead from the LED board, (viii) was not installed and/or operated in accordance with ATG Electronics instructions and guidelines, (ix) has been mishandled, misused, abused, tampered with, modified or altered by anyone other than ATG ELECTRONICS, (x) has been subjected to abnormal stresses and operating conditions, or (xi) has been operated without overvoltage and lightning protection devices in place.

Limitations

Disclaimers & Limitations of Liability

The foregoing warranty is exclusive of all other statutory, written or oral warranties and no other warranties of any kind, statutory, by operation of law or course of performance, or otherwise, are given, here-in expressed or otherwise received. EXCEPT AS EXPRESSLY PROVIDED ABOVE, ATG ELECTRONICS DISCLAIMS ALL REPRESENTATIONS, WARRANTIES AND CONDITIONS OF ANY KIND, EXPRESS OR IMPLIED, REGARDING THE LED PRODUCTS AND ITS SERVICES, INCLUDING, WITHOUT LIMITATION, THE IMPLIED WARRANTIES OF MERCHANTABILITY AND FITNESS FOR A PARTICULAR USE OR PURPOSE.

LIMITATION OF LIABILITY. Other than the obligation to repair or replace as provided above, ATG Electronics shall have no liability for any losses, expenses or damages as a result of the installation, use, inability to use, removal or replacement of any LED product. ATG Electronics will not under any circumstances whether as a result of breach of contract, breach of warranty, tort, strict liability or otherwise be liable for consequential, incidental, special or exemplary damages including but not limited to, loss of profits or revenues, loss of any other goods or associated equipment or damage to any associated equipment, cost of capital, cost of substitute products, facilities or services, down time cost or claims of claimant's customers. ATG Electronics liability on any claim of any kind for any loss or damages arising out of, resulting from or concerning any LED product, any aspect of this warranty or for any products or services furnished hereunder shall not exceed the price of the fixture which gives rise to the claim.

Return and Repair Procedures

All warranty requests and or questions are to be directed to ATG Electronics Customer Service Department (CSD) at 888-618-7298. If deemed necessary, the CSD will issue a Returned Merchandise Authorization (RMA) number which must be included on both the packing slip of the component or fixture being returned and on the outside of the box. You must include your name and contact information, including your email address, on the packing slip so that we can contact you easily. Each component or fixture must be packaged very carefully and properly so as to prevent damages in shipment and must be shipped freight prepaid. Please obtain a proof of delivery to ensure that the material is received.

Once the component or fixture has been received and tested, an evaluation report will be provided to the end user via email. This report will clarify the following:

- A) The component / fixture is covered under the warranty policy and will either be repaired or replaced.
- B) The component / fixture is not covered under the warranty policy and the reason for this determination.

If ATG ELECTRONICS determines that the component or fixture is covered under the warranty, then the appropriate repairs will be started or a replacement fixture will be manufactured and shipped. Please note that in the event the returned component or fixture is found not to be covered under this warranty, you may be subject to a labor charge for the evaluation process and will be responsible for all return shipping charges and fees. For components and fixtures determined to be covered under this warranty prior to the first anniversary of the Sale Date, the repaired or replacement component or fixture will be returned to you at no charge. You will be responsible for all other shipping charges.

No Labor Reimbursement

All components and fixtures determined to be covered by this warranty as provided above, will be repaired or replaced at no charge to the customer, however, except as expressly provided above with respect to recessed and linear fixtures during the first year, the customer must hire and pay for an electrician to remove and reinstall such components and fixtures. No labor costs will be covered for the removal or reinstallation of any components or fixtures. The warranty does not cover modifications, repairs or replacements, or the related labor or materials costs, that may be necessary to facilities or third party products in connection with the removal, repair, or replacement of any LED product under this warranty.